

LA MINUTE D'INSPIRATION
#2 LE FOOD
MARKET
BAR & RESTO

Par **AKTUEL**

#2 FOOD MARKET

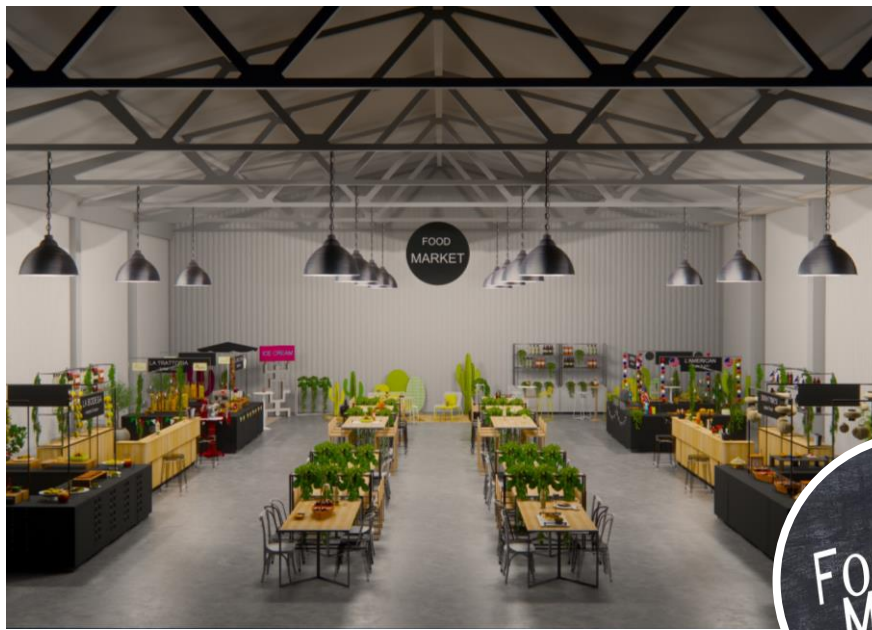

1. LAMPE HALO
2. COMPTOIR UP AVEC MÂT ET LAMPES GLOBES
3. CONSOLE UP AVEC ÉCHELLES
4. TABOURET HANNA
5. TABOURET MOSKITO
6. BUFFET UP AVEC MÂT ET BARRE
7. TABLE GROG
8. TOTEM KACTUS MAGENTA
9. CLOISON SMART AVEC POTS
10. TRIPORTEUR À GLACES
11. TRANCHEUSE MANUELLE

#2 ESPACE RESTAURATION



1.TABLE STAN 2.CHAISE GOA 3.TABLE IVAN 4.CLOISON SMART AVEC POTS
5.FAUTEUIL PAPILLON GOA 6.TABOURETS GOA 7.MANGE-DEBOUT STAN





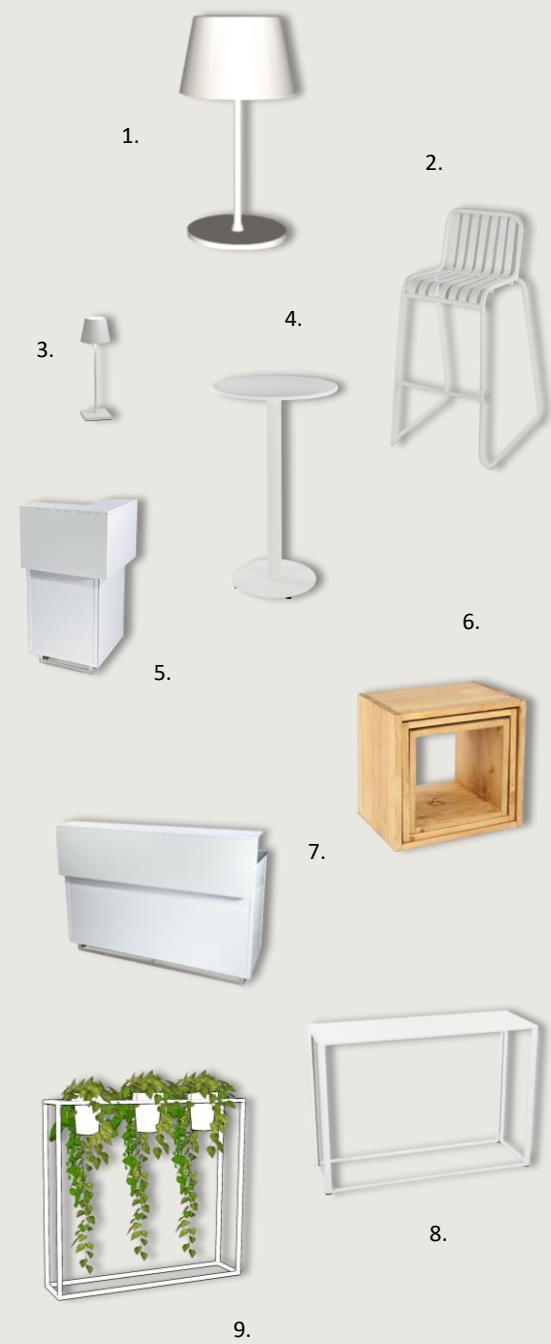





#2 BAR À CHAMPAGNE



1.LAMPADAIRE MEZZO 2.TABOURET MOLI 3.LAMPE HALO
4.MANGE-DEBOUT MOLI 5.COMPTOIR D'ANGLE UP 6.OPEN
CUBE WOOD 7.BAR UP 8.TABLE KADRA 9.CLOISON SMART AVEC
POTS

#2 DÉJEUNER BUFFET



1. 
2. 
3. 
4. 
5. 
6. 
7. 
8. 

1.TABLE STAN 2.CHAISE HANNA
3.MANGE-DEBOUT STAN 4.TABOURET HANNA 5.
ÉTAGÈRE AVEC CUBES 6.BUFFET UP AVEC MÂT ET
BARRE ENSEIGNE 7.BUFFET UP AVEC ÉCHELLES 8.BUFFET
UP



#2 BAR À COKTAIL

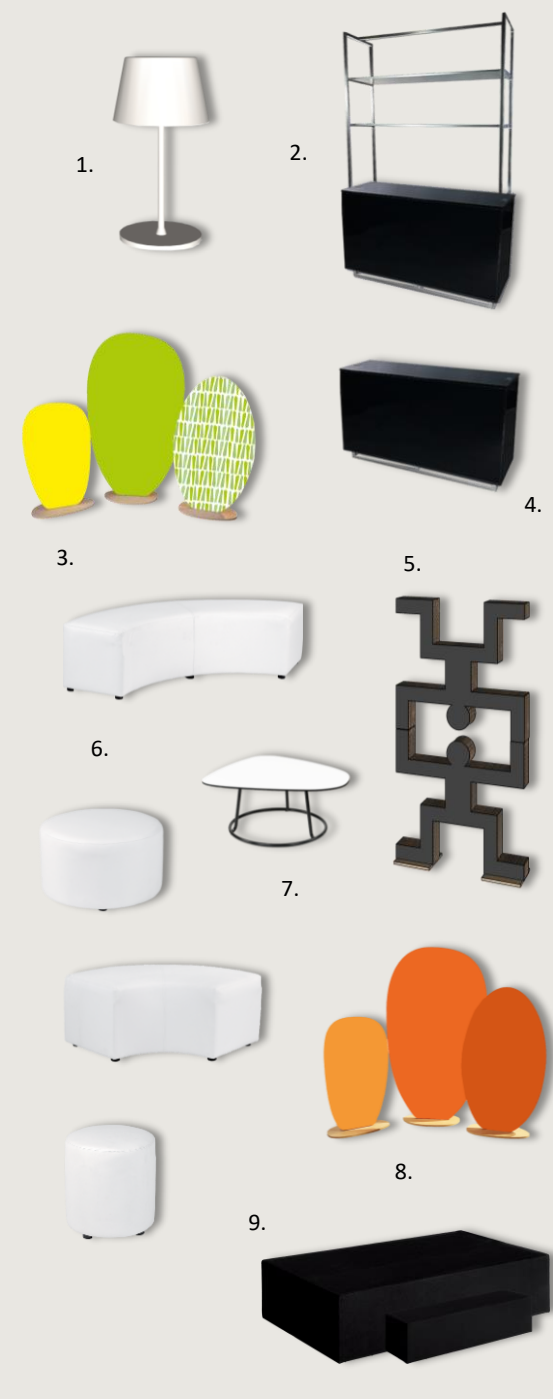

1.LAMPADAIRE MEZZO 2. CONSOLE UP AVEC ÉCHELLES 3 & 8.PARAVENT 3 PÉTALES 4.CONSOLE UP RÉTRO ÉCLAIRÉE 5.TOTEM KOH 6.ENSEMBLE NIKKI 7.TABLE S KAPSULE 9.MONOBLOC & MARCHE ESTRADÉ

#2 COCKTAIL DÎNATOIRE

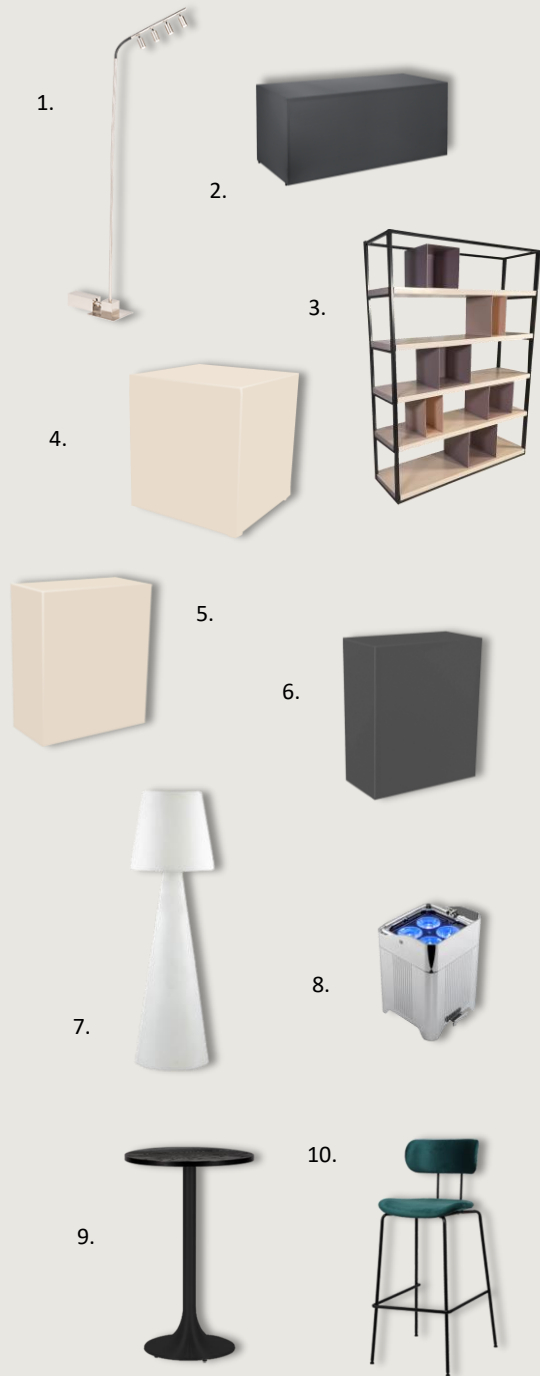
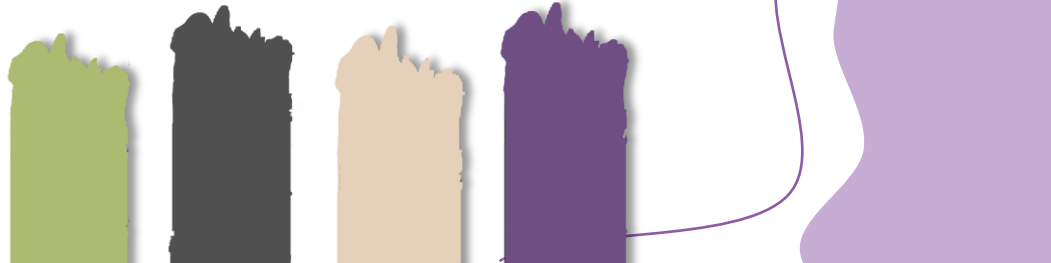
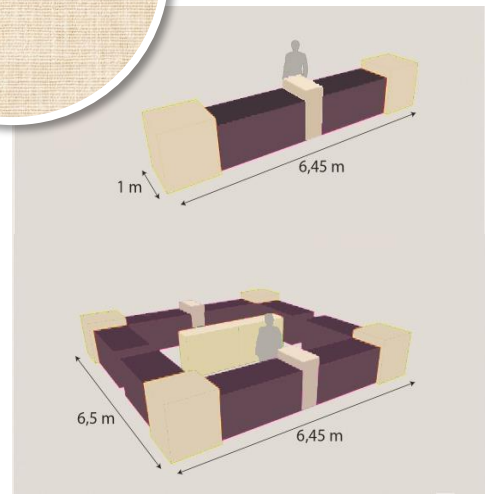

1.LAMPADAIRE POLLUX 2,4,5 & 6.GAMME BOX DE 14 COLORIS EN HOUSSE LYCRA 3.ÉTAGÈRE AVEC CUBES 7.LAMPADAIRE PIVOT 8.PROJECTEUR LED 9.MANGE-DEBOUT STACY 10.TABOURET DANTE

NOUS CONTACTER

PARIS

36 avenue du
1^{er} mai
91127 PALAISEAU

01.41.80.30.30

CANNES

61 route de
la Marigarde
06131 GRASSE

04.92.60.60.80

AKTUEL